

# Electrofusion Fittings 20-110

Weldable fitting system for Flexalen<sup>®</sup> polybutene service pipes (PB-H) OD20-110mm

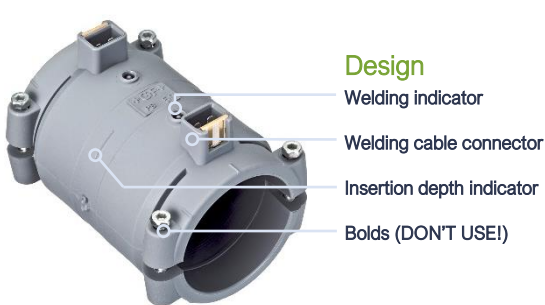

## Application Instruction

### Application conditions and pipe preparation

- Ambient temperature: +5 to +40°C
  - No rainy or windy ( $\geq 3$  bfr / 3.4-5.4 m/s) weather conditions
  - Service pipe is cut straight and without damage, EVOH Layer is removed (see instruction leaflet for scraper)
  - Service pipe and fitting are free from dirt and condensation
- } use a tent to create correct conditions if not already given

**IMPORTANT: FOR WELDING PROCESS ONLY FOLLOW THE INSTRUCTIONS BELOW:**



**01.**  
Position the pipes to be welded in a tension-free position.



**02.**  
Clean the service pipes by using PB cleaner and tissues and make circular movements over the entire welding surface. Make sure that any printing on the service pipe is properly removed.



**03.**  
Mark the correct insertion depth for the electrofusion fitting on the service pipes. Insertion depth is indicated on the fitting.

**Important:** Make sure the EVOH layer is removed for this section of the pipe!

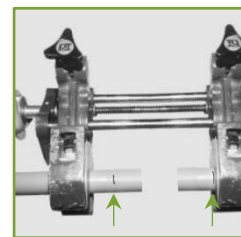

**04.**  
Fix the service pipe with the clamping set by placing the clamps in a way that:

On the "fixed" side: only the insertion depth is visible;  
On the "moving" side: insertion depth + at least 2cm is visible.

### Disclaimer

All recommendations and information provided on this data sheet are based on our knowledge and experience. Product specifications are intended as guidelines. Since conditions of service are beyond our control, users must satisfy themselves that products are suitable for the intended use. No guarantee or warranty is given or implied or that any use of products will not infringe rights belonging to other parties. We reserve the right to change product design and properties without notification.



05. Clean the fitting by making circular movements over the entire internal welding surface of the fitting.

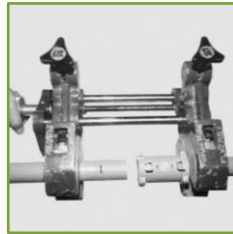

06. Slide the fitting over the service pipe on the "fixed" side of the clamping set and position it right against the welding clamp.

**Important:** Don't use bolts on the fitting!



07. Join the service pipes by turning the handwheel on the clamping set. Make sure that the other service pipe slides into the fitting smoothly. Check that the correct insertion depth has been reached.

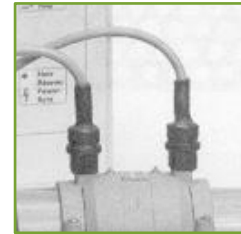

08. Connect the welding machine to power supply and the welding cables to the fitting - the corresponding "ready" indicator lights up.

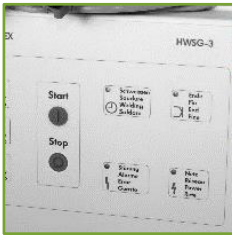

09. Press "Start" to begin the warming up process. The "Welding" indicator lights up.

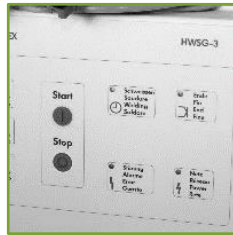

10. After the warming up process has been completed there will be a sound signal and the "end" indicator lights up. Now, the welding cables can be removed carefully from the fitting.



11. After a cooling time of at least 15 min (20 min for fittings with OD110mm) clamping set can be removed.

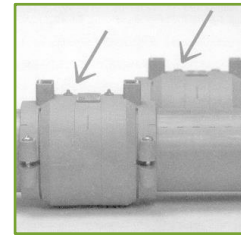

12. Check if the welding process was successful: the welding indicators came up, the insertion depth markings are visible directly next to the fitting and there are no visible damages or irregularities.

**Note:** After the last welded connection is established and cooled down, wait at least 2 hours before starting the pressure testing procedure.

## Welding parameters

Fitting dimension OD [mm]	Insertion depth l [mm]	Warming up time [sec]	Cooling time [min]
16	38	37	15
20	40	47	15
25	42	55	15
32	42	70	15
40	47	120	15
50	49	145	15
63	51	180	15
75	67	150	15
90	74	200	15
110	80	210	20